

FUNCTIONAL REVISIONS:
ALL REVISIONS WITH SOLID
TRIANGLE ARE USABLE

REVISIONS		
▲04	02-25-04	JS
▲4	ECN #E06091	
ADDED LABELS TO SWITCH PLATE WIRES		
▲05	04-18-06	BM

WIRES FROM SWITCH PLATE

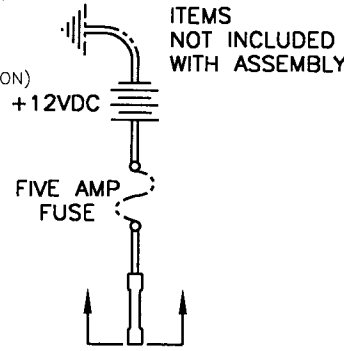
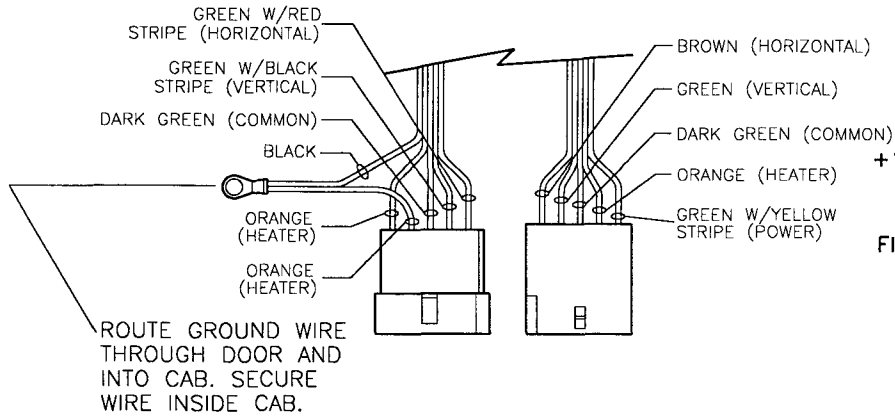

CONNECTION INSIDE R.H. COVER PLATE

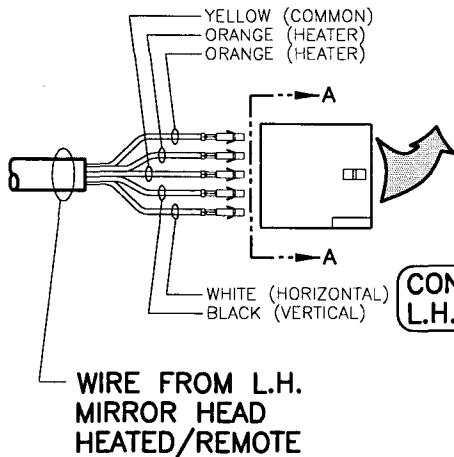

CONNECTION INSIDE L.H. COVER PLATE

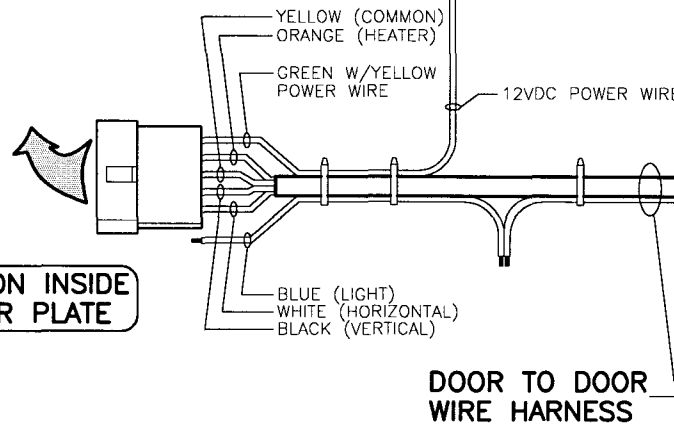

DOOR TO DOOR WIRE HARNESS

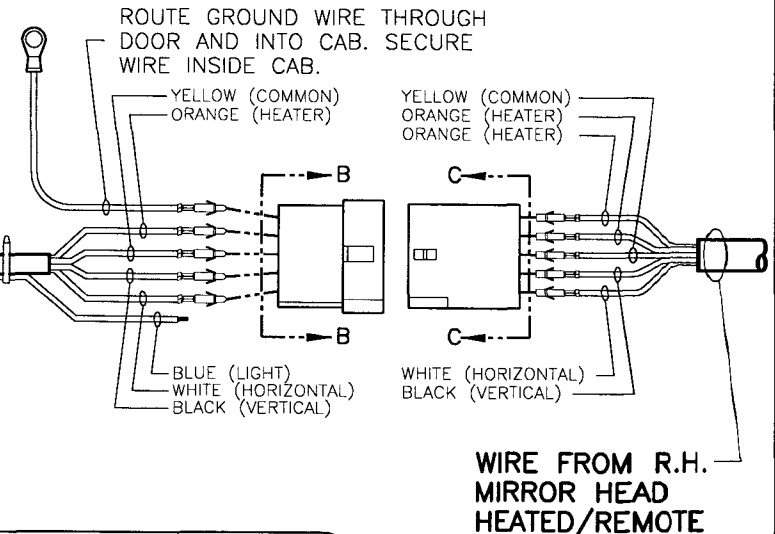

WIRE FROM R.H. MIRROR HEAD HEATED/REMOTE

FOR HEATED/REMOTE MIRRORS SEE PAGE 1
FOR HEATED/REMOTE/LIGHTED MIRRORS SEE PAGE 2

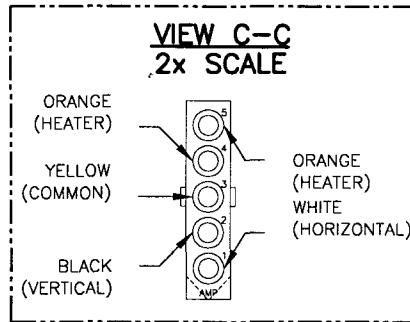
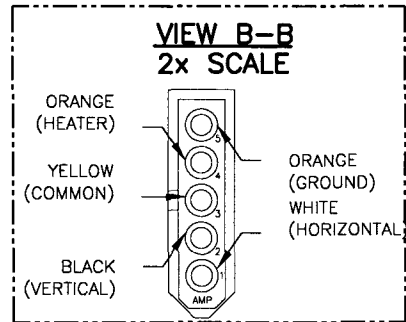
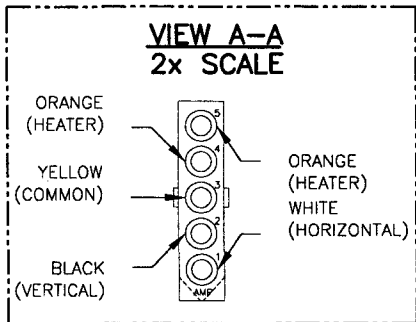

PROPRIETARY
THIS CONCEPT & DRAWING IS THE PROPERTY OF VELVAC, INC. AND SHALL NOT BE REPRODUCED, COPIED, DISCLOSED, USED FOR THE MANUFACTURE OR PROCUREMENT FROM SOURCES OTHER THAN VELVAC INC., WITHOUT WRITTEN PERMISSION FROM VELVAC INC.

VELVAC

SCALE: X X X
DATE: 04-09-99
DRAWN BY: J.S.

ORIGINAL

WIRING INSTRUCTIONS
2020 MIRROR ASSY'S
CHEVY G-VAN

DRAWING NUMBER: PAGE 1 OF 2
7476322

WIRES FROM SWITCH PLATE

FUNCTIONAL REVISIONS:
ALL REVISIONS WITH SOLID TRIANGLE ARE USABLE

REVISIONS
SEE PAGE 1 OF 3

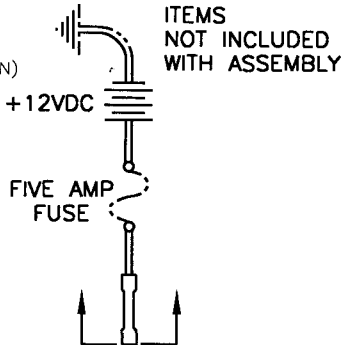
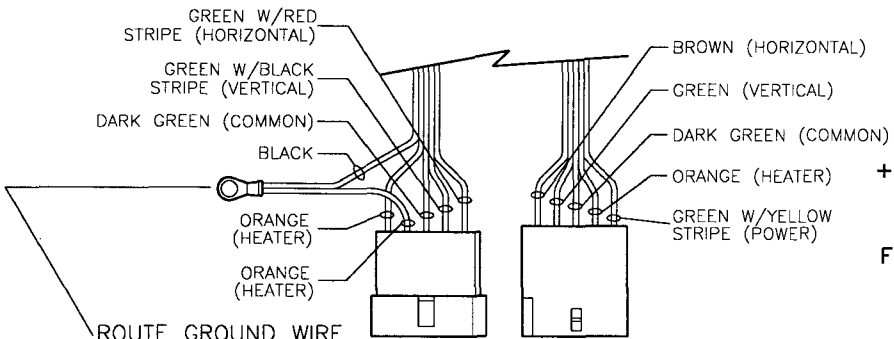

CONNECTION INSIDE R.H. COVER PLATE

ROUTE GROUND WIRE THROUGH DOOR AND INTO CAB. SECURE WIRE INSIDE CAB.

ROUTE GROUND WIRE THROUGH DOOR AND INTO CAB. SECURE WIRE INSIDE CAB.

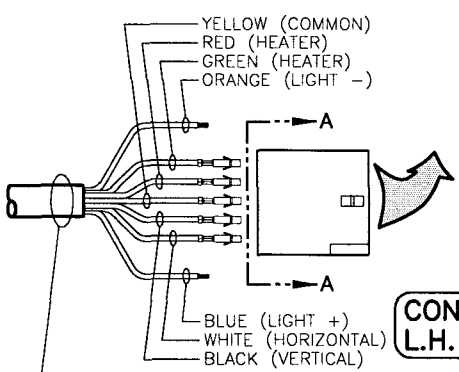

CONNECTION INSIDE L.H. COVER PLATE

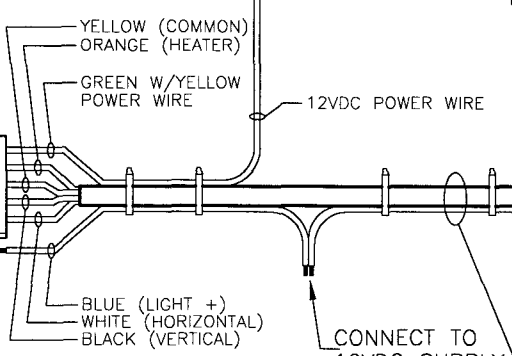

CONNECT TO 12VDC SUPPLY

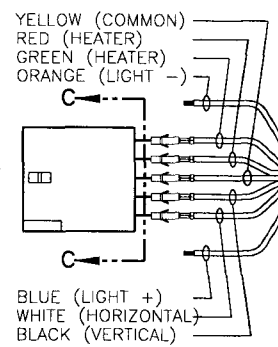
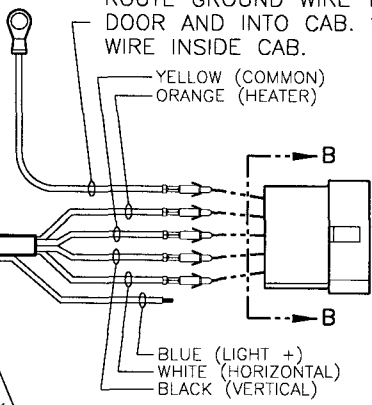

WIRE FROM R.H. MIRROR HEAD HEATED/REMOTE

WIRE FROM L.H. MIRROR HEAD HEATED/REMOTE

FOR HEATED/REMOTE MIRRORS SEE PAGE 1
FOR HEATED/REMOTE/LIGHTED MIRRORS SEE PAGE 2

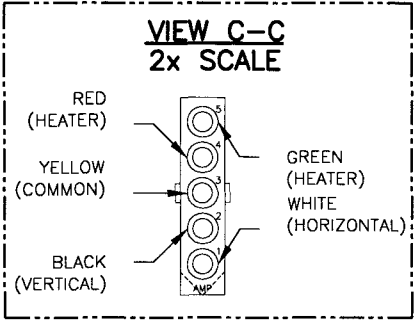
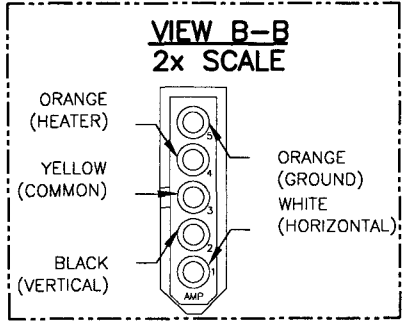
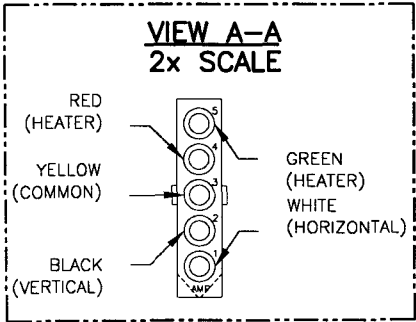

PROPRIETARY
THIS CONCEPT & DRAWING IS THE PROPERTY OF VELVAC, INC. AND SHALL NOT BE REPRODUCED, COPIED, DISCLOSED, USED FOR THE MANUFACTURE OR PROCUREMENT FROM SOURCES OTHER THAN VELVAC, INC., WITHOUT WRITTEN PERMISSION FROM VELVAC, INC.

VELVAC
ORIGINAL

SCALE: X X X
DATE: 04-09-99
DRAWN BY: J.S.

WIRING INSTRUCTIONS
2020 MIRROR ASSY'S
CHEVY G-VAN

DRAWING NUMBER: PAGE 2 OF 2
7476322